

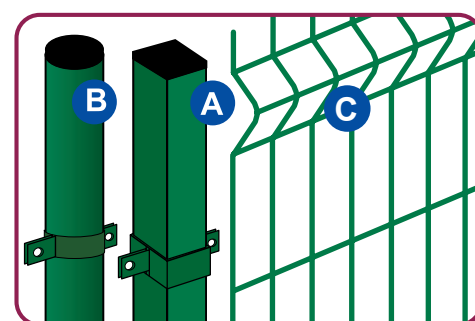

Recinzioni

- pag. 30 PANNELLO "VILLA"
- 32 PALI "ANTRACITE" E ACCESSORI
- 33 PALI "VERDI" E ACCESSORI
- 34 PANNELLO "VILLA DECOR"
- 35 PANNELLO "DOPPIO FILO"
- 36 CANCELLI "VILLA" VERDE RAL 6005
- 37 CANCELLI "BRICO" CON PIASTRA
- 38 PANNELLO "VILLA ZINCATO"
- 40 PANNELLO "GRIGLIATO" ELETTROSALDATO
- 42 CANCELLI GRIGLIATO ELETTROSALDATO

PANNELLO "VILLA"

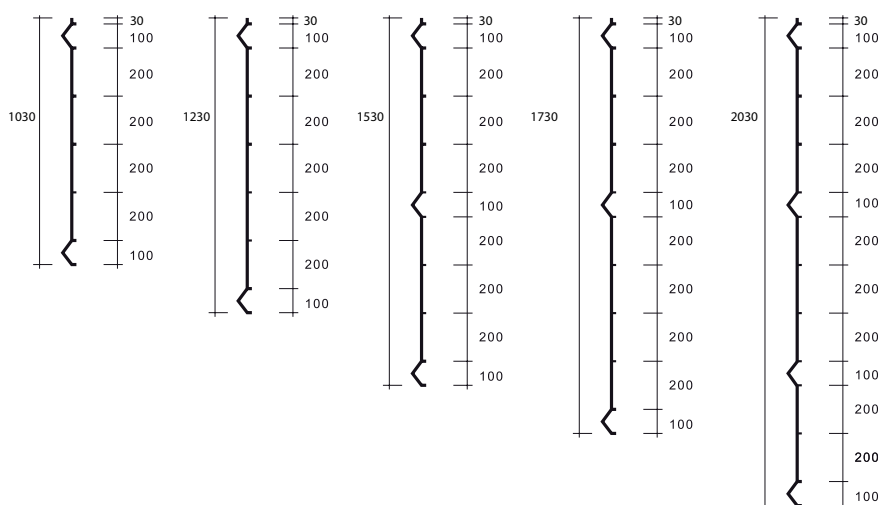
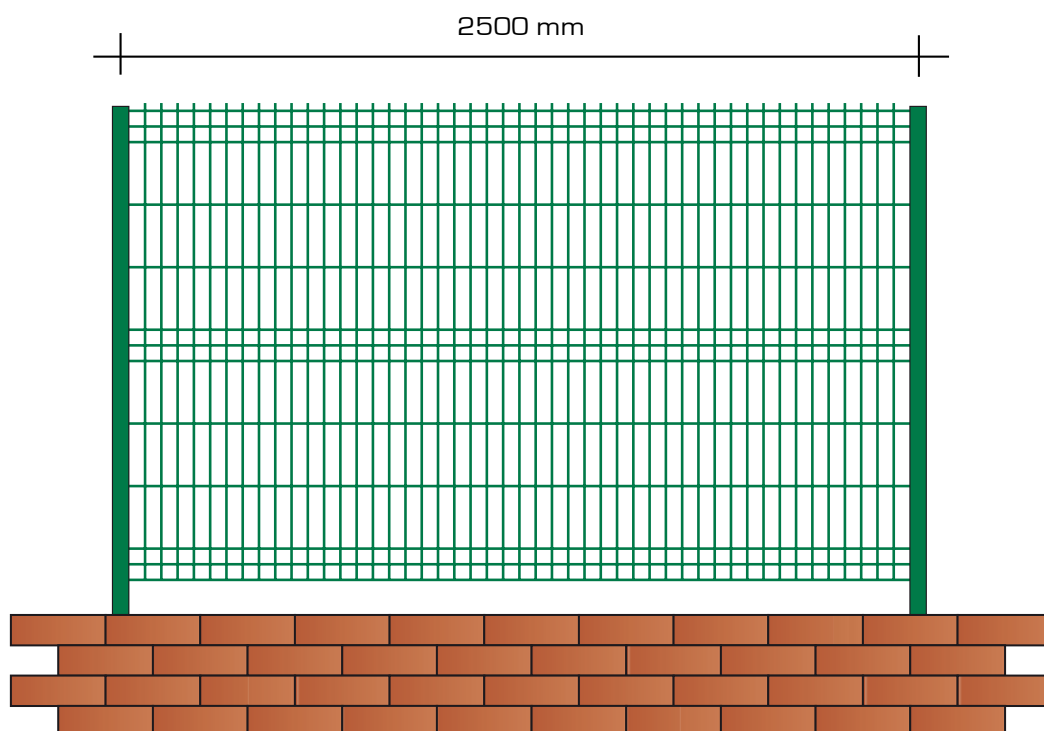

appoggiare il pannello C sul montante A o B

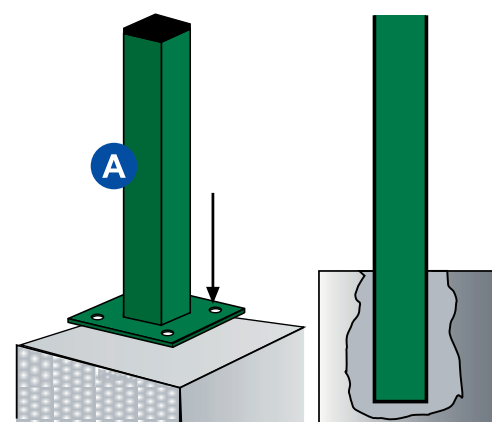

con piastra cementato
Sistemi di Fissaggio del montante.

COLORI DISPONIBILI

Verde

RAL6005

Micaceo



Zincato



COLORI POSSIBILI

Giallo

RAL1018

Rosso

RAL3020

Bianco

RAL9003

Arancione

RAL2004

Blu

RAL5002

Grigio



PANNELLO "VILLA"



Pannello realizzato con fili zincati, saldati e verniciati

PANNELLO "VILLA STANDARD VERDE" RAL 6005 - filo 5,00 mm

Codice	maglia mm	filo	H x L mm	Costo €/cad	SCONTO %
RE0002	200x50	5/5	1030x2500	33,00	
RE0003	200x50	5/5	1230x2500	39,50	
RE0004	200x50	5/5	1530x2500	49,00	
RE0005	200x50	5/5	1730x2500	55,50	
RE0006	200x50	5/5	2030x2500	65,00	

confezioni da 50 pezzi

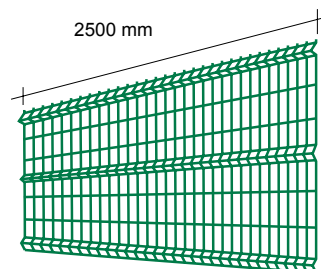

PANNELLO "VILLA CORTO VERDE" RAL 6005 - filo 5,00 mm

Codice	maglia mm	filo	H x L mm	Costo €/cad	SCONTO %
RE0028	200x50	5/5	1030x2000	26,80	
RE0029	200x50	5/5	1230x2000	32,00	
RE0030	200x50	5/5	1530x2000	40,00	
RE0032	200x50	5/5	1730x2000	45,50	
RE0031	200x50	5/5	2030x2000	52,80	

confezioni da 50 pezzi

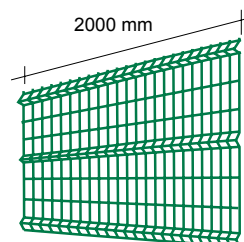

PANNELLO "VILLA PROMO VERDE" RAL 6005 - filo 4,00 mm

Codice	maglia mm	filo	H x L mm	Costo €/cad	SCONTO %
RE0053	200x50	4/4	1030x2000	20,60	
RE0054	200x50	4/4	1230x2000	24,60	
RE0055	200x50	4/4	1530x2000	30,60	
RE0056	200x50	4/4	1730x2000	34,60	
RE0057	200x50	4/4	2030x2000	40,60	

confezioni da 50 pezzi

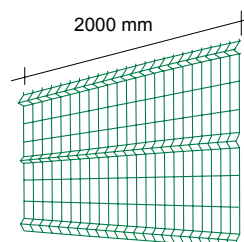

PANNELLO "VILLA STANDARD ANTRACITE" RAL 7016 - filo 5,00 mm

Codice	maglia mm	filo	Altezza mm	Costo €/cad	SCONTO %
RE0188	200x50	5/5	1030x2500	35,00	
RE0189	200x50	5/5	1230x2500	43,00	
RE0190	200x50	5/5	1530x2500	53,50	
RE0191	200x50	5/5	1730x2500	66,50	
RE0192	200x50	5/5	2030x2500	71,00	

confezioni da 50 pezzi

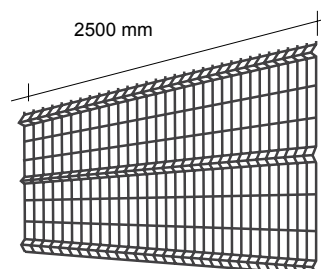

PANNELLO "VILLA CORTO ANTRACITE" RAL 7016 - filo 5,00 mm

Codice	maglia mm	filo	Altezza mm	Costo €/cad	SCONTO %
RE0214	200x50	5/5	1030x2000	30,00	
RE0215	200x50	5/5	1230x2000	32,00	
RE0216	200x50	5/5	1530x2000	40,00	
RE0217	200x50	5/5	1730x2000	45,50	
RE0218	200x50	5/5	2030x2000	52,80	

confezioni da 50 pezzi

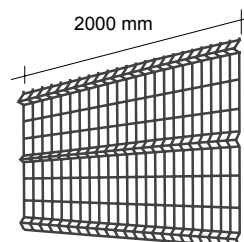

PALI "ANTRACITE" E ACCESSORI



PALO QUADRO GRIGIO ANTRACITE da CEMENTARE

Codice	misura mm	spessore mm	Altezza mm	Costo €/cad	SCONTO %
RE0265	60x60	1,5	1350	19,00	
RE0266	60x60	1,5	1530	22,00	
RE0267	60x60	1,5	1830	25,50	
RE0268	60x60	1,5	2000	27,50	
RE0269	60x60	1,5	2330	32,00	

PALO QUADRO GRIGIO ANTRACITE CON PIASTRA

Codice	misura mm	spessore mm	Altezza mm	Costo €/cad	SCONTO %
RE0291	60x60	1,5	1070	23,00	
RE0292	60x60	1,5	1270	25,50	
RE0293	60x60	1,5	1570	29,00	
RE0294	60x60	1,5	1770	32,00	
RE0295	60x60	1,5	2070	35,50	

FISSAGGIO PER PALO QUADRO GRIGIO ANTRACITE

			completo di bulloni	€/cad	SCONTO %
RE0296	60x60		intermedio	4,00	
RE0297	60x60		finale	4,40	
RE0298	60x60		angolo	4,80	

PALO TONDO GRIGIO 48 da CEMENTARE

Codice	misura mm	spessore mm	Altezza mm	Costo €/cad	SCONTO %
RE0347	48	1,5	1350	12,70	
RE0348	48	1,5	1530	14,30	
RE0349	48	1,5	1830	17,10	
RE0350	48	1,5	2000	18,70	
RE0351	48	1,5	2330	22,00	

PALO TONDO GRIGIO 48 CON PIASTRA

Codice	misura mm	spessore mm	Altezza mm	Costo €/cad	SCONTO %
RE0320	48	1,5	1070	15,20	
RE0321	48	1,5	1270	17,20	
RE0322	48	1,5	1570	20,50	
RE0323	48	1,5	1770	22,60	
RE0324	48	1,5	2070	26,40	

FASCETTA GRIGIO MICACEO PER PALO TONDO 48 mm

			completo di bulloni	€/cad	SCONTO %
RE0325	48		intermedio	3,80	
RE0326	48		finale	4,40	

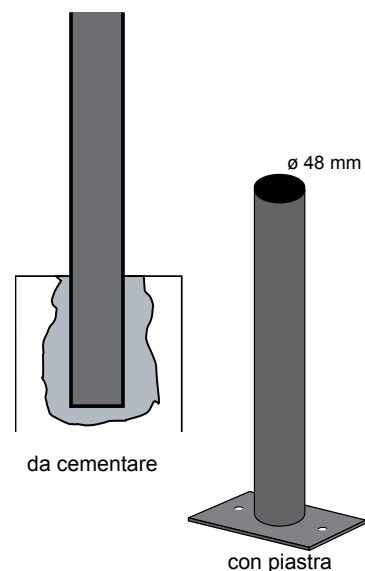
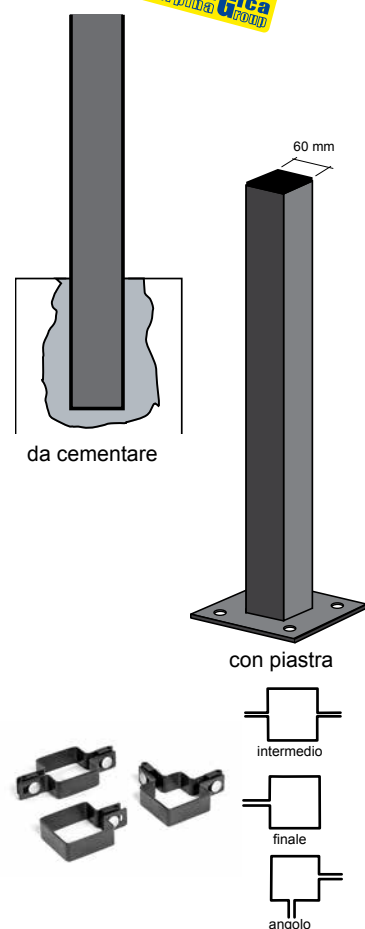

PALI "VERDI" E ACCESSORI



PALO QUADRO VERDE da CEMENTARE

Codice	misura mm	spessore mm	Altezza mm	Costo €/cad	SCONTO %
RE0079	60x60	1,5	1350	17,00	
RE0080	60x60	1,5	1530	20,00	
RE0081	60x60	1,5	1830	23,00	
RE0082	60x60	1,5	2000	25,00	
RE0083	60x60	1,5	2330	29,00	

PALO QUADRO VERDE CON PIASTRA

Codice	misura mm	spessore mm	Altezza mm	Costo €/cad	SCONTO %
RE0105	60x60	1,5	1070	20,50	
RE0106	60x60	1,5	1270	23,00	
RE0107	60x60	1,5	1570	26,00	
RE0108	60x60	1,5	1770	29,00	
RE0109	60x60	1,5	2070	32,00	

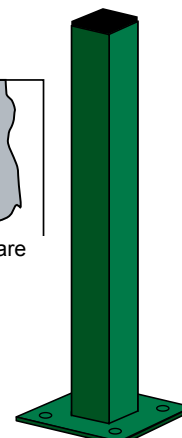
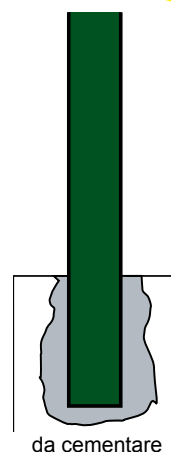

FISSAGGIO PER PALO QUADRO VERDE 60x60 mm

		completo di bulloni	€/cad	SCONTO %
RE0110	60x60	intermedio	3,60	
RE0111	60x60	finale	4,00	
RE0112	60x60	angolo	4,50	

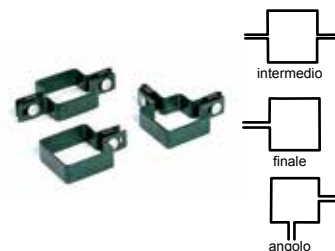

PALO TONDO VERDE 48 da CEMENTARE

Codice	misura mm	spessore mm	Altezza mm	Costo €/cad	SCONTO %
RE0161	48	1,5	1350	11,50	
RE0162	48	1,5	1530	13,00	
RE0163	48	1,5	1830	15,50	
RE0164	48	1,5	2000	17,00	
RE0165	48	1,5	2330	20,00	

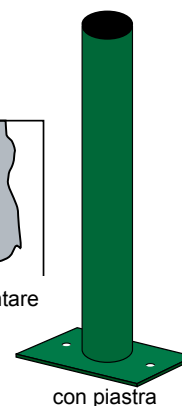
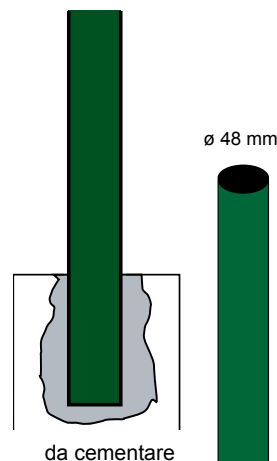

PALO TONDO VERDE 48 CON PIASTRA

Codice	misura mm	spessore mm	Altezza mm	Costo €/cad	SCONTO %
RE0134	48	1,5	1070	13,80	
RE0135	48	1,5	1270	15,60	
RE0136	48	1,5	1570	18,60	
RE0137	48	1,5	1770	20,50	
RE0138	48	1,5	2070	24,00	



FASCETTA VERDE PER PALO TONDO 48 mm

		completo di bulloni	€/cad	SCONTO %
RE0139	48	intermedio	3,40	
RE0166	48	finale	4,00	

PANNELLO "VILLA DECOR"



Pannello realizzato con fili zincati, saldati e verniciati

"DECOR PANEL LINEAR VERDE" RAL 6005 - filo 5,00 mm

Codice	maglia mm	filo	H x L mm	Costo €/cad	SCONTO %
RE0206	150x50	5/5	1000x2000	70,00	
RE0207	150x50	5/5	1200x2000	84,00	
RE0208	150x50	5/5	1500x2000	105,00	
RE0209	150x50	5/5	2000x2000	140,00	

confezioni da 50 pezzi

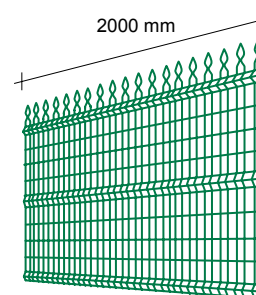

"DECOR PANEL ONDA VERDE" RAL 6005 - filo 5,00 mm

Codice	maglia mm	filo	H x L mm	Costo €/cad	SCONTO %
RE0221	150x50	5/5	1000x2000	80,00	
RE0222	150x50	5/5	1200x2000	96,00	
RE0223	150x50	5/5	1500x2000	120,00	
RE0224	150x50	5/5	2000x2000	160,00	

confezioni da 50 pezzi

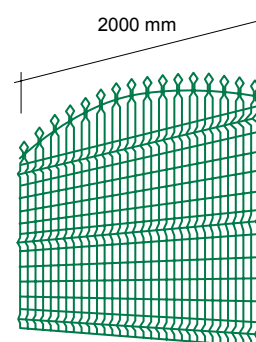

"RAZOR PANEL VERDE" RAL 6005 - filo 5,00 mm

Codice	maglia mm	filo	H x L mm	Costo €/cad	SCONTO %
RE0227	200x50	5/5	1000x2000	70,00	
RE0228	200x50	5/5	1200x2000	84,00	
RE0229	200x50	5/5	1500x2000	105,00	
RE0230	200x50	5/5	2000x2000	140,00	

confezioni da 50 pezzi

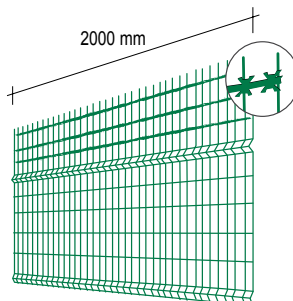

"SECURITY PANEL 12x76 VERDE" RAL 6005 - filo 5,00 mm

Codice	maglia mm	filo	H x L mm	Costo €/cad	SCONTO %
RE0233	12.7x76.2	5/5	1000x2500	200,00	
RE0234	12.7x76.2	5/5	1200x2500	240,00	
RE0235	12.7x76.2	5/5	1500x2500	300,00	
RE0236	12.7x76.2	5/5	2000x2500	400,00	

confezioni da 50 pezzi

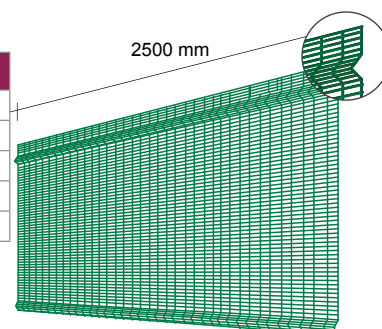

PANNELLO "DOPPIO FILO"



Pannello realizzato con doppio filo zincato orizzontale e un filo verticale

PANNELLO "DOPPIO FILO VERDE" RAL 6005 filo 8/6/8

Codice	maglia mm	fili orizzontali mm	filo verticale mm	H x L mm	Costo €/cad	SCONTO %
RE0572	200x55	8-8	6	1030x2500	100,00	
RE0573	200x55	8-8	6	1230x2500	123,00	
RE0574	200x55	8-8	6	1430x2500	143,00	
RE0575	200x55	8-8	6	1630x2500	163,00	
RE0576	200x55	8-8	6	1830x2500	183,00	
RE0577	200x55	8-8	6	2030x2500	203,00	
RE0578	200x55	8-8	6	2230x2500	223,00	
RE0579	200x55	8-8	6	2430x2500	243,00	

confezioni da 50 pezzi

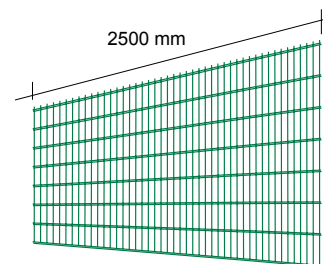

PANNELLO "DOPPIO FILO GRIGIO ANTRACITE" RAL 7016 filo 8/6/8

Codice	maglia mm	fili orizzontali mm	filo verticale mm	H x L mm	Costo €/cad	SCONTO %
RE0612	200x55	8-8	6	1030x2500	110,00	
RE0613	200x55	8-8	6	1230x2500	135,00	
RE0614	200x55	8-8	6	1430x2500	157,00	
RE0615	200x55	8-8	6	1630x2500	179,00	
RE0616	200x55	8-8	6	1830x2500	200,00	
RE0617	200x55	8-8	6	2030x2500	223,00	

confezioni da 50 pezzi

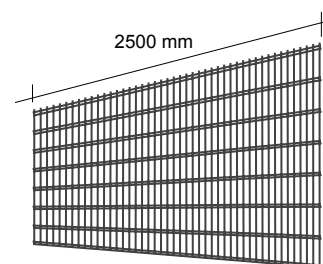

PANNELLO "DOPPIO FILO ELITE VERDE" RAL 6005 filo 8/6/8

Codice	maglia mm	fili orizzontali mm	filo verticale mm	H x L mm	Costo €/cad	SCONTO %
RE0171	160x75	8-8	6	1030x2000	120,00	
RE0172	160x75	8-8	6	1230x2000	150,00	
RE0173	160x75	8-8	6	1430x2000	180,00	
RE0174	160x75	8-8	6	1630x2000	200,00	
RE0175	160x75	8-8	6	1830x2000	220,00	
RE0176	160x75	8-8	6	2030x2000	240,00	

confezioni da 50 pezzi

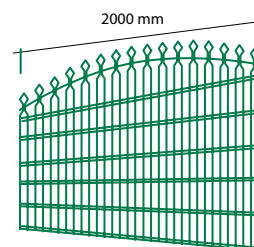

PANNELLO "DOPPIO FILO ELITE ANTRACITE" RAL 7016 filo 8/6/8

Codice	maglia mm	fili orizzontali mm	filo verticale mm	H x L mm	Costo €/cad	SCONTO %
RE0179	160x75	8-8	6	1030x2000	130,00	
RE0180	160x75	8-8	6	1230x2000	160,00	
RE0181	160x75	8-8	6	1430x2000	186,00	
RE0182	160x75	8-8	6	1630x2000	210,00	
RE0183	160x75	8-8	6	1830x2000	240,00	
RE0184	160x75	8-8	6	2030x2000	265,00	

confezioni da 50 pezzi

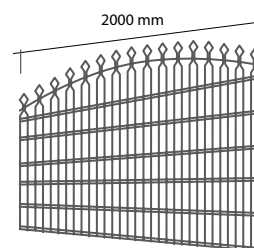

CANCELLI "VILLA" VERDE RAL 6005



DETTAGLI TECNICI

CANCELLO PEDONALE zincato e verniciato modello "Villa" - confezione 1 pz in cartone

Codice	PILASTRO mm	TELAIO mm	LARGHEZZA cm	ALTEZZA cm	PREZZO €PZ	SCONTO %
RE0499	60X60X2	50X50X2	100	103	450,00	
RE0500	60X60X2	50X50X2	100	123	500,00	
RE0501	60X60X2	50X50X2	100	153	650,00	
RE0502	60X60X2	50X50X2	100	173	700,00	
RE0503	60X60X2	50X50X2	100	203	900,00	

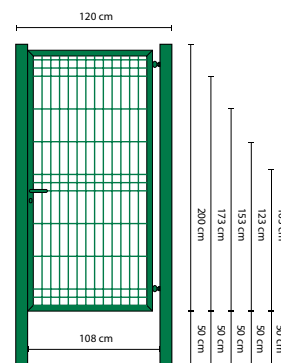

CANCELLO A 2 ANTE zincato e verniciato modello "Villa"

Codice	PILASTRO mm	TELAIO mm	LARGHEZZA cm	ALTEZZA cm	PREZZO €PZ	SCONTO %
RE0534	100X100X3	50X50X3	300	163	2200,00	
RE0535	100X100X3	50X50X3	300	183	2500,00	
RE0536	100X100X3	50X50X3	300	213	2900,00	
RE0537	100X100X3	50X50X3	400	163	3000,00	
RE0538	100X100X3	50X50X3	400	183	3300,00	
RE0539	100X100X3	50X50X3	400	213	3850,00	
RE0540	100X100X3	50X50X3	500	163	3700,00	
RE0541	100X100X3	50X50X3	500	183	4150,00	
RE0542	100X100X3	50X50X3	500	213	4800,00	



FUORI STANDARD colore SU RICHIESTA	colore su richiesta	su misura	su misura	Euro / Mq 500,00
---------------------------------------	------------------------	-----------	-----------	---------------------

CANCELLO scorrevole zincato e verniciato modello "Villa"

Codice	PILASTRO mm	TELAIO mm	LARGHEZZA cm	ALTEZZA cm	PREZZO €PZ	SCONTO %
RE0603	100X100X3	100X50X3	400	143	2300,00	
RE0604	100X100X3	100X50X3	400	173	2800,00	
RE0605	100X100X3	100X50X3	400	193	3100,00	
RE0601	100X100X3	100X50X3	500	143	2900,00	
RE0606	100X100X3	100X50X3	500	173	3500,00	
RE0607	100X100X3	100X50X3	500	193	3900,00	
RE0610	100X100X3	100X50X3	600	143	3500,00	
RE0608	100X100X3	100X50X3	600	173	4150,00	
RE0609	100X100X3	100X50X3	600	193	4650,00	



FUORI STANDARD colore SU RICHIESTA	colore su richiesta	su misura	su misura	Euro / Mq 450,00
---------------------------------------	------------------------	-----------	-----------	---------------------

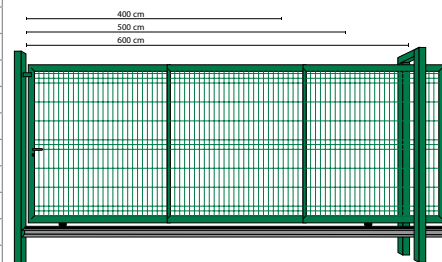
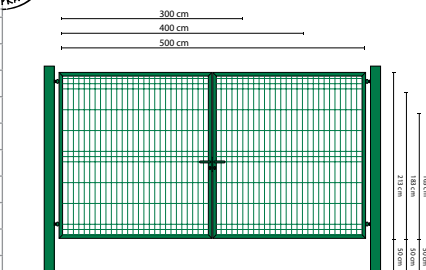

Metallurgica Irpina S.p.A.
Società Unipersonale
Via Fontana Angelica, 1
83031 ARIANO IRPINO (AV)

+39 0825 892127
+39 0825 892171
+39 0825 891107
FAX +39 0825 892635

info@irpina.com
vendite@irpina.com
acquisti@irpina.com
metallurgica@irpina.com

Numero Verde
800-12 67 62

CANCELLI "BRICO" CON PIASTRA



DETTAGLI TECNICI

CANCELLO PEDONALE "BRICO" maglia 50x50 - colore VERDE

Codice	PILASTRO con PIASTRA	LARGHEZZA	ALTEZZA	PREZZO	SCONTO
	mm	cm	cm	€PZ	%
RE0413	60	100	100	300,00	
RE0414	60	100	125	350,00	
RE0415	60	100	150	400,00	
RE0416	60	100	175	450,00	
RE0417	60	100	200	500,00	

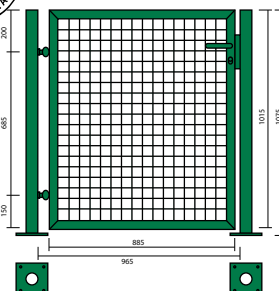

FISSAGGIO VERDE FINALE per PALO TONDO da 60 mm

Codice	DIAMETRO	LUNGHEZZA	PREZZO	SCONTO
	mm	cm	€PZ	%
RE0420	60	14	6,00	



CANCELLO PEDONALE "BRICO" maglia 50x50 - colore GRIGIO MICACEO

Codice	PILASTRO con PIASTRA	LARGHEZZA	ALTEZZA	PREZZO	SCONTO
	mm	cm	cm	€PZ	%
RE0423	60	100	100	320,00	
RE0424	60	100	125	375,00	
RE0425	60	100	150	430,00	
RE0426	60	100	175	485,00	
RE0427	60	100	200	540,00	

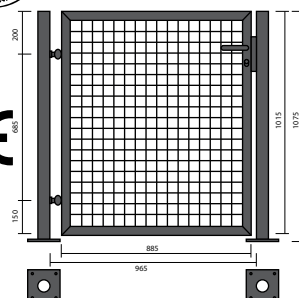

FUORI STANDARD		su misura	su misura	Euro / Mq
colore SU RICHIESTA				

FISSAGGIO GRIGIO MICACEO FINALE per PALO TONDO da 60 mm

Codice	DIAMETRO	LUNGHEZZA	PREZZO	SCONTO
	mm	cm	€PZ	%
RE0430	60	14	7,00	



PANNELLO "VILLA ZINCATO"

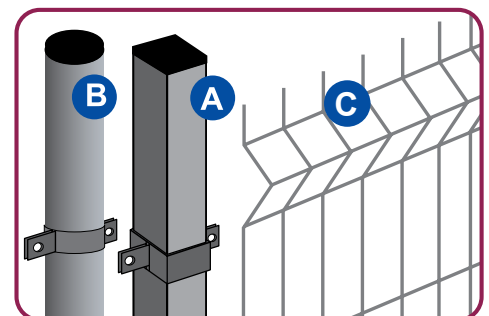
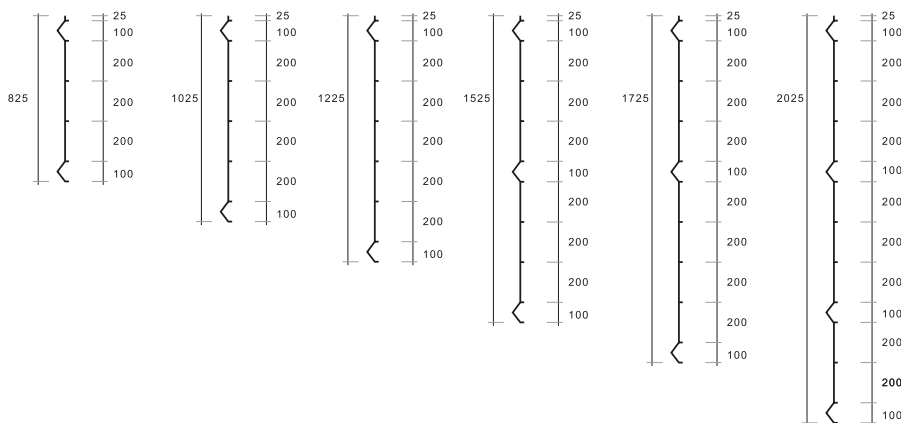
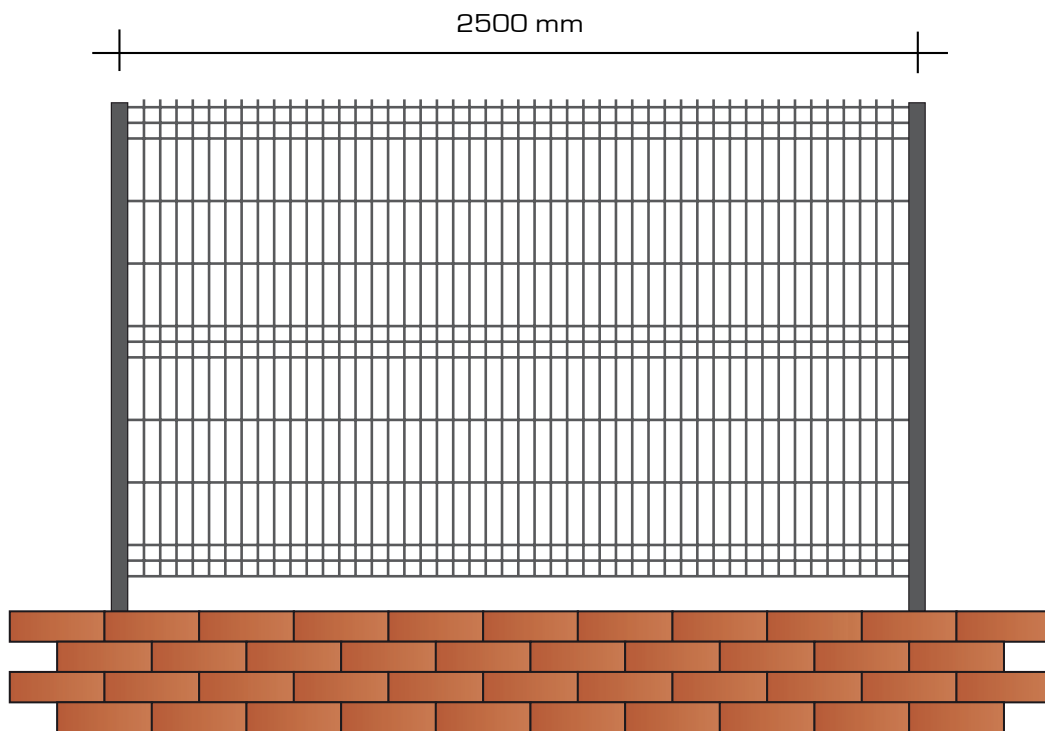

appoggiare il pannello C sul montante A o B

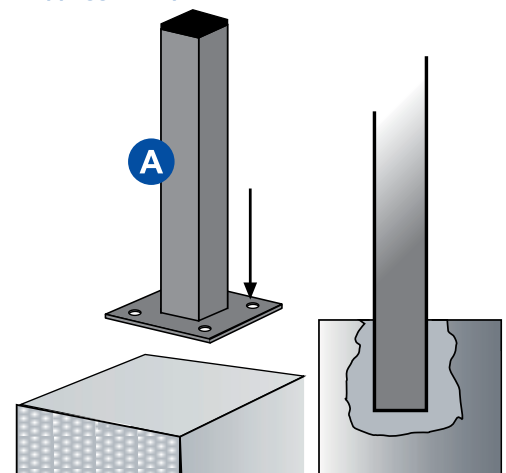

con piastra cementato
Sistemi di Fissaggio del montante.

PANNELLO "VILLA ZINCATO"



Pannello realizzato con fili zincati e saldati

PANNELLO "VILLA ZINCATO" maglia 200x50 filo 5/5 interasse 2500

Codice	maglia mm	filo	Altezza mm	Costo €/cad	SCONTO %
RE0358	200x50	5/5	1030x2500	29,00	
RE0359	200x50	5/5	1230x2500	35,00	
RE0360	200x50	5/5	1530x2500	43,00	
RE0361	200x50	5/5	1730x2500	49,00	
RE0362	200x50	5/5	2030x2500	58,00	

PANNELLO "VILLA ZINCATO" maglia 200x50 filo 4/4 interasse 2000

Codice	maglia mm	filo	Altezza mm	Costo €/cad	SCONTO %
RE0373	200x50	4/4	1030x2000	18,00	
RE0374	200x50	4/4	1230x2000	22,20	
RE0375	200x50	4/4	1530x2000	27,50	
RE0376	200x50	4/4	1730x2000	31,14	
RE0377	200x50	4/4	2030x2000	36,54	

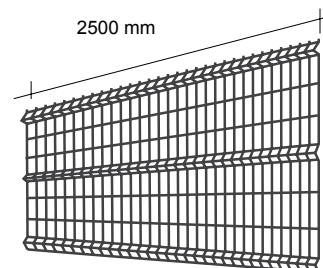

Recinzioni

PALO TONDO ZINCATO 48 da CEMENTARE

Codice	misura mm	spessore mm	Altezza mm	Costo €/cad	SCONTO %
RE0353	48	1,5	1350	8,10	
RE0354	48	1,5	1530	9,20	
RE0355	48	1,5	1830	11,00	
RE0356	48	1,5	2000	12,00	
RE0357	48	1,5	2330	14,00	

PALO TONDO ZINCATO 48 CON PIASTRA

Codice	misura mm	spessore mm	Altezza mm	Costo €/cad	SCONTO %
RE0506	48	1,5	1070	*	
RE0507	48	1,5	1270	*	
RE0508	48	1,5	1570	*	
RE0509	48	1,5	1770	*	
RE0510	48	1,5	2070	*	

FASCETTA ZINCATA PER PALO TONDO 48 mm

		completo di bulloni	€/cad	SCONTO %
RE0511	48	intermedio	3,20	
RE0528	48	finale	3,70	

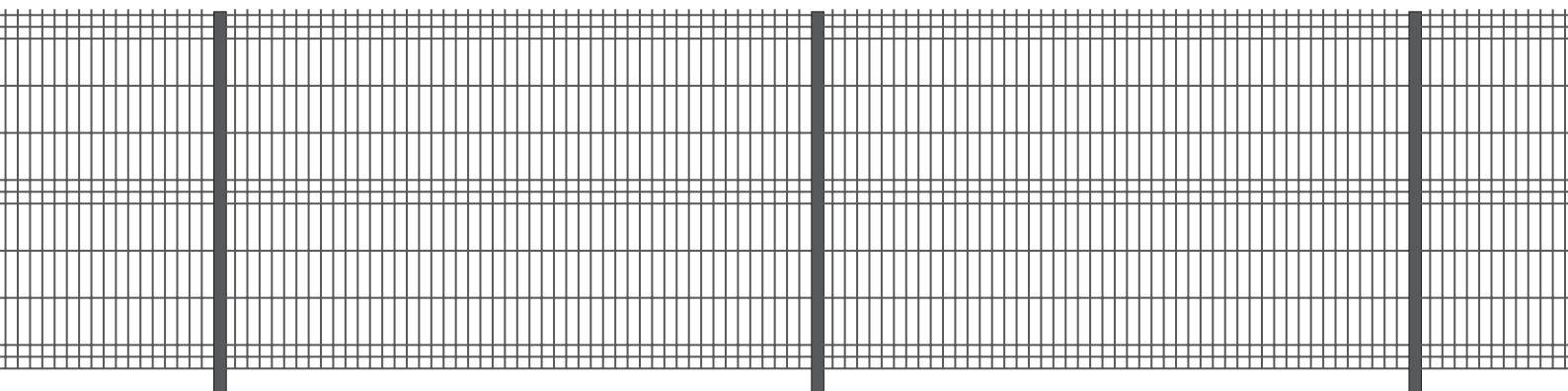
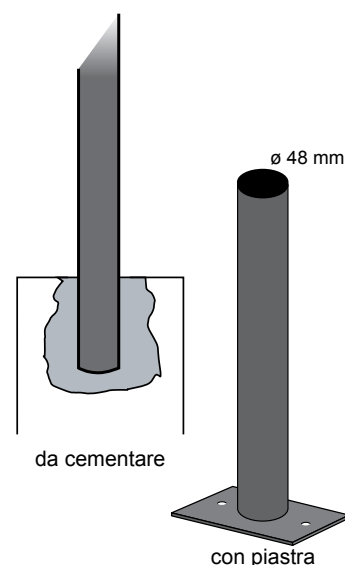

PANNELLO "GRIGLIATO" ELETTROSALDATO

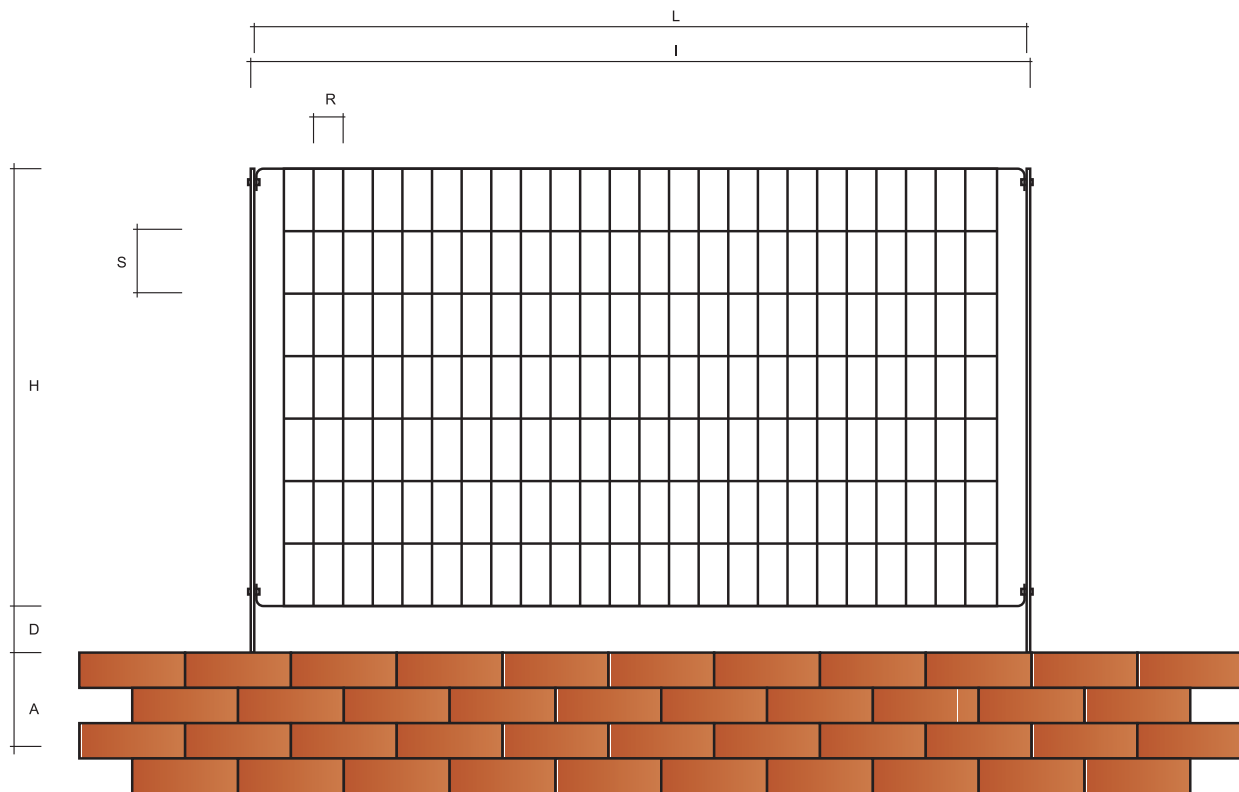

scala 1:15

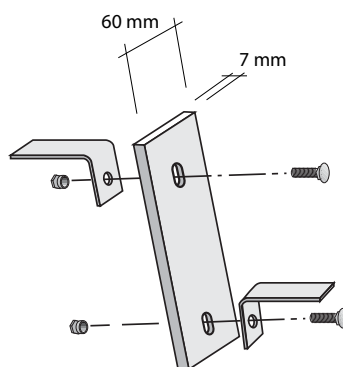
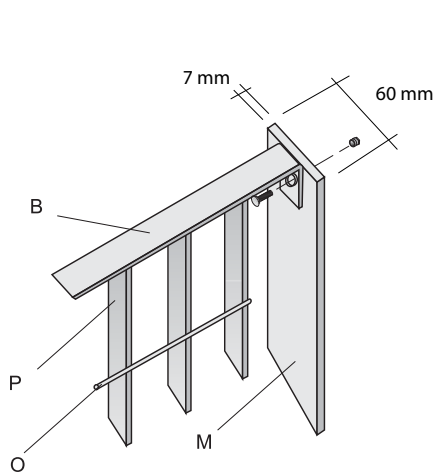

Montanti con doppia foratura per tratti in pendenza



Sistemi di Fissaggio del montante.

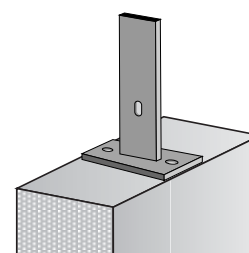

con piastra

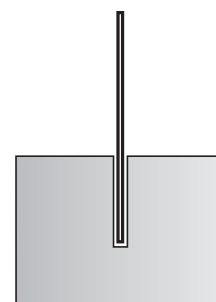

cementato

GRIGLIATO ELETTROSALDATO



Codice	maglia mm	piatto mm	H x L mm	Costo €/cad	SCONTO %
zincato a caldo MAGLIA 62x132 - Piatto 25x2 - interasse 2000					
RE0379	62x132	25x2	930x1992	63,00	
RE0380	62x132	25x2	1200x1992	76,80	
RE0381	62x132	25x2	1326x1992	83,50	
RE0382	62x132	25x2	1460x1992	88,50	
RE0383	62x132	25x2	1722x1992	104,00	
RE0384	62x132	25x2	1988x1992	118,00	

2000 mm

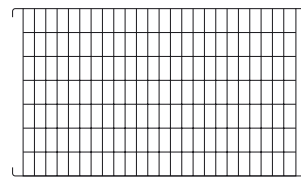

Codice	maglia mm	piatto mm	H x L mm	Costo €/cad	SCONTO %
zincato a caldo MAGLIA 62x66 - Piatto 25x2 - interasse 2000					
RE0440	62x66	25x2	930x1992	84,00	
RE0441	62x66	25x2	1200x1992	102,00	
RE0442	62x66	25x2	1326x1992	110,00	
RE0443	62x66	25x2	1460x1992	120,00	
RE0444	62x66	25x2	1722x1992	136,00	
RE0445	62x66	25x2	1988x1992	155,00	

2000 mm

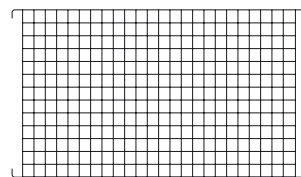

Codice	spessore mm	Altezza mm	Costo €/cad	SCONTO %
PIANTANA DA CEMENTARE 60x7 - ZINCATO A CALDO				
RE0450	60x7	1200	16,00	
RE0451	60x7	1500	20,00	
RE0452	60x7	1620	22,00	
RE0512	60x7	1750	23,50	
RE0513	60x7	2000	26,70	
RE0514	60x7	2400	32,00	
RE0453	80x8	2500	*	

PIANTANA CON PIASTRE 60x7

RE0474	60x7	1008	18,00	
RE0475	60x7	1272	22,00	
RE0476	60x7	1408	24,00	
RE0477	60x7	1536	25,50	
RE0478	60x7	1808	30,00	
RE0479	60x7	2050	33,00	

ACCESSORI

RE0480	Aletta di compensazione Zincata	Costo €/cad	5,00	
RE0526	Bullone INOX + dado INOX M10	Costo €/cad	0,90	

TRATTAMENTI

Extra per verniciatura e Poliestere	Costo €/mq	65,00	
-------------------------------------	------------	--------------	--

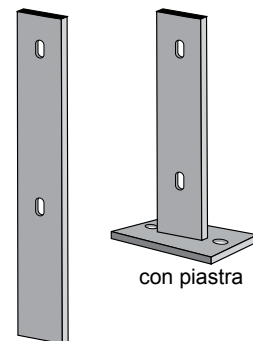

da cementare

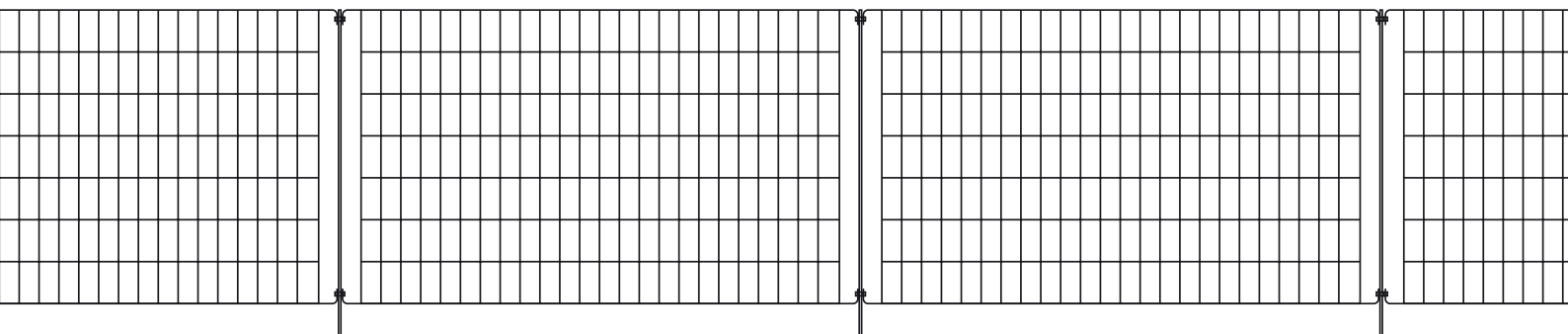
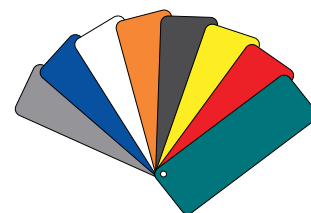

CANCELLI GRIGLIATO ELETTROSALDATO



SCORREVOLI IN GRIGLIATO ZINCATO A CALDO

Codice	largh mm	Altezza mm	Pilastri mm	Telaio mm	Zoccolo mm	Grigliato mm	Zincato €/cad	SCONTO %
RE0620	4000	2000	100x100x3	100x50x3	100x50x3	62x132-25x2	3600,00	
RE0621	4000	2300	100x100x3	100x50x3	100x50x3	62x132-25x2	4140,00	
RE0622	5000	2000	100x100x3	100x50x3	100x50x3	62x132-25x2	4500,00	
RE0623	5000	2300	100x100x3	100x50x3	100x50x3	62x132-25x2	5175,00	

C E

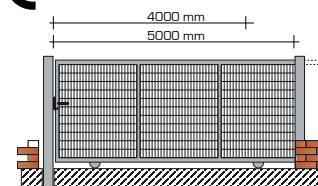

A DUE ANTE IN GRIGLIATO ZINCATO A CALDO

Codice	largh mm	Altezza mm	Pilastri mm	Telaio mm	Zoccolo mm	Grigliato mm	Zincato €/cad	SCONTO %
RE0630	3000	2000	100x100x3	100x50x3	100x50x3	62x132-25x2	3000,00	
RE0631	3000	2300	100x100x3	100x50x3	100x50x3	62x132-25x2	3450,00	
RE0632	4000	2000	100x100x3	100x50x3	100x50x3	62x132-25x2	4000,00	
RE0633	4000	2300	100x100x3	100x50x3	100x50x3	62x132-25x2	4600,00	
RE0634	5000	2000	100x100x3	100x50x3	100x50x3	62x132-25x2	5000,00	
RE0635	5000	2300	100x100x3	100x50x3	100x50x3	62x132-25x2	5750,00	

C E

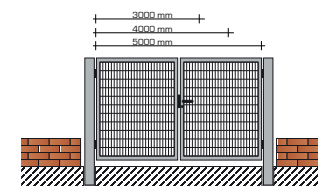

AD UN'ANTA IN GRIGLIATO ZINCATO A CALDO

Codice	largh mm	Altezza mm	Pilastri mm	Telaio mm	Zoccolo mm	Grigliato mm	Zincato €/cad	SCONTO %
RE0636	1000	2000	100x100x3	100x50x3	100x50x3	62x132-25x2	1300,00	
RE0637	1000	2300	100x100x3	100x50x3	100x50x3	62x132-25x2	1495,00	
RE0638	1200	2000	100x100x3	100x50x3	100x50x3	62x132-25x2	1560,00	
RE0639	1200	2300	100x100x3	100x50x3	100x50x3	62x132-25x2	1800,00	

C E

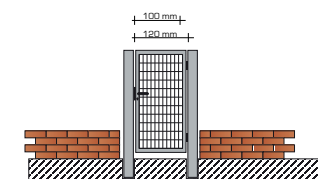

Cancelli fuori STANDARD	SCORREVOLI	€/mq	500,00
su misura ZINCATI a CALDO	A DUE ANTE	€/mq	600,00
	AD UNA ANTA	€/mq	700,00
Extra costo di verniciatura		€/mq	65,00

